

INSTALLATION INSTRUCTIONS

For Model 7210-01

READ AND SAVE THESE INSTRUCTIONS

These instructions are provided for your safety. It is very important that they are read carefully and completely before beginning installation of the lighting fixture. We strongly suggest that all direct wired fixtures be installed by a qualified, licensed electrician.

WARNING! SHUT POWER OFF AT FUSE OR CIRCUIT BREAKER.

BEFORE INSTALLATION

AVERTISSEMENT! COUPER LE COURANT AU NIVEAU DES FUSIBLES OU DU DISJONCTEUR.

PREPARING FOR INSTALLATION

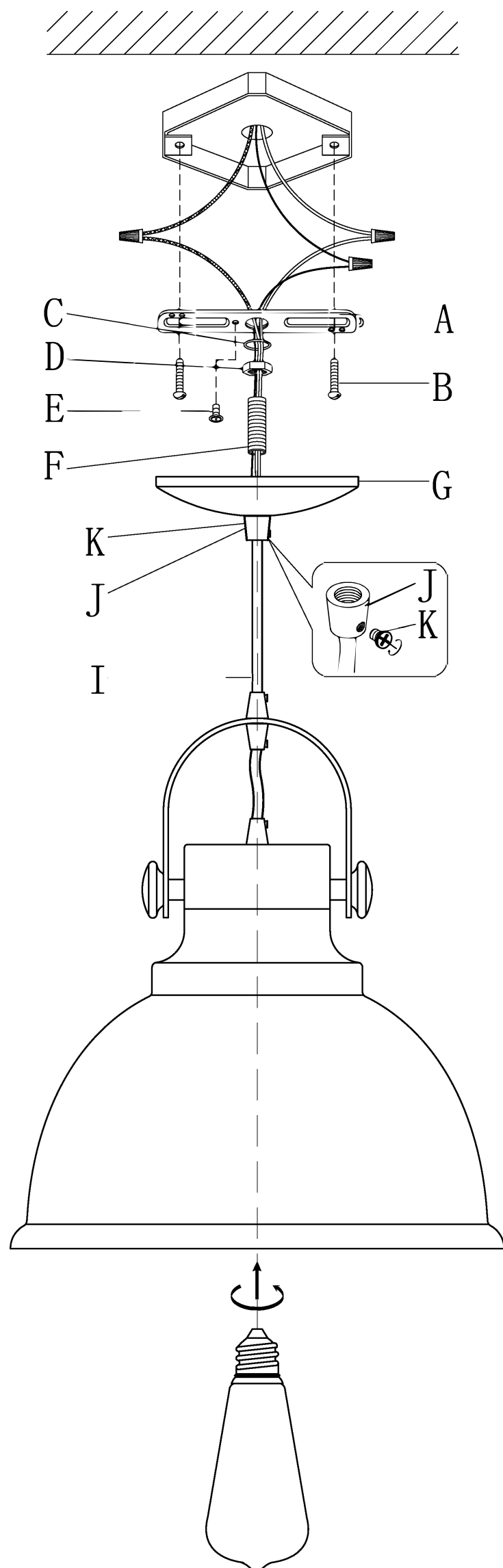

Remove all contents from the carton. See the important notes above. Shut off the power at the circuit breaker and completely remove the old fixture from the ceiling, including the old mounting strap.

Remove the mounting strap assembly from the bag. One end of nipple (F) should be attached to mounting bracket (A) with washer and hex nut (C, D) in place. The other end should have canopy loop (H) attached.

Attach mounting bracket (A) to the junction box by securely tightening the mounting screws (B). Unscrew canopy loop ring (I) from canopy loop (H). Pass canopy (G) over the canopy loop (H) so that it's against the ceiling. Adjust position of nipple (F) on mounting bracket (A) so that canopy (G) covers at least half exterior threads on the canopy loop (H) while it's securely connected to nipple (F). Once ideal position of nipple (F) is determined, tighten up the washer (C) and hex nut (D) on the nipple (F) right beneath the mounting bracket (A) to secure the nipple in place.

CONNECTING THE WIRES

Slide cord (I) through cord grip (J) to adjust the wire to desirable length. Use set screw (K) to lock it tight. Attach the power supply wires from the junction box to the fixture's wires. Connect black to black (or smooth); white to white (or ribbed); ground to ground (green or copper). Twist the end of the wire pairs together, and then twist on a wire connector. Make sure all twists are in the same direction. If there is no ground wire (green or copper) from the junction box, locate ground screw on mounting plate (B) and wrap the fixture's ground wire around the green ground screw. Use a screwdriver to secure the ground screw onto the mounting plate. Tuck all wires neatly into the junction box.

FINISHING THE INSTALLATION

Raise canopy (G) to mounting plate (B) and position mounting screws (A) so that they protrude through the openings of canopy (G). Secure canopy (G) in place with decorative nuts (F).

Install light bulb (not included) in accordance with the fixture's specifications. Do not exceed the recommended maximum wattage.

Your installation is now complete. Turn on the power and test the fixture.

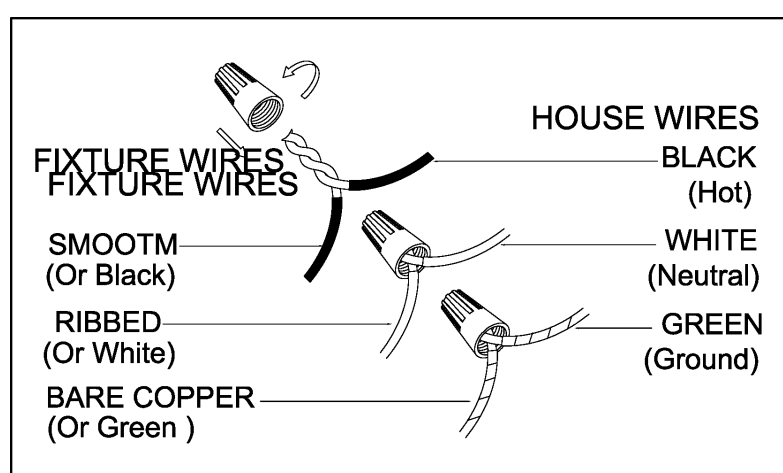

CLEANING TIPS

Treat the fixture gently! Regular cleaning will reduce the need for deep cleaning. For regular cleaning, turn off the light and wipe down the fixture with a clean lint-free cotton or microfiber cloth. Never spray cleaner directly onto the fixture.